

BCM:Connect

Remote Cellular Boiler Diagnostics Device

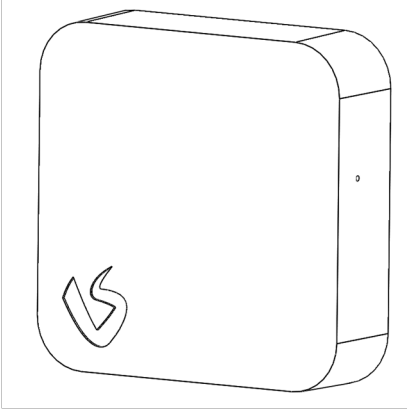

Pack Contains: 1x BCM:Connect

Device Information

BCM:Connect

Model: BXA

Supply Voltage: 230V AC 50Hz

Boiler Connection: 0-24V DC

AFV Connection: 0-6V DC

2G / NBIOT / CAT M1 Connected



Designed in the UK



Made in China

Vericon Systems

Unit 5, Churchill Industrial Estate,
Churchill Road, Cheltenham,
GL53 7EG

www.vericonsystems.com

Support: support@vericonsystems.com

Safety and Guidelines

The BCM:Connect (BCM) should only be installed by a competent person.



ALWAYS ISOLATE THE MAINS SUPPLY BEFORE INSTALLING OR WORKING ON ANY COMPONENTS THAT REQUIRE A 230V AC SUPPLY

The BCM is intended for internal use only.

The BCM requires a mobile GSM signal to operate. The BCM should be installed in a location with strong GSM signal. A GSM Signal strength analyser can be used to test the signal strength.

Compatibility

The BCM works with all three major bus protocols; eBus, EMSBus and OpenTherm.

For a list of compatible boilers visit:
www.vericonsystems.com/bcmconnectcompatibleboilers

Installation

1. Scan the QR Code on the device to begin the installation and commissioning.

If the code cannot be scanned, visit app.vericon.co.uk to input the serial number and begin the install and commissioning.

2. Isolate the main supply

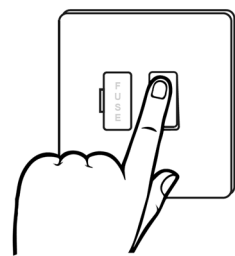

ALWAYS ISOLATE THE MAINS SUPPLY BEFORE INSTALLING OR WORKING ON ANY COMPONENTS THAT REQUIRE A 230V AC SUPPLY

Installation

3. Unclip the wall mount from the BCM.

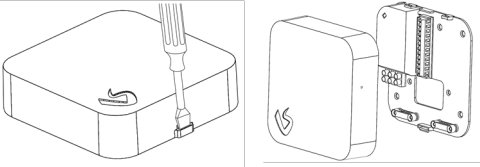

4. Fix the wall mount in a suitable position or use the backbox mounting holes as shown below.

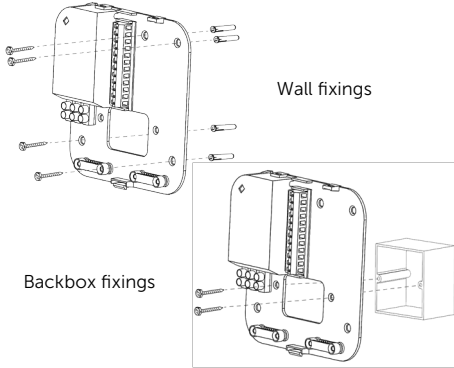

Installation

6. Remove cable knockouts on the bottom of the BCM as required.

7. Connect the BCM to the wall mount.

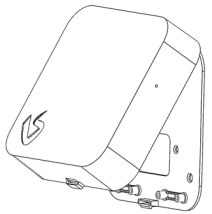

8. Turn the boiler power on and ensure RED LED is lit

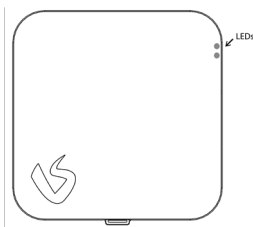

9. Complete the commissioning process within the online portal.

Installation

5. Terminate the necessary cables from the boiler, supply and external devices into the backplate. If using the backbox, do not use the cable clamps.

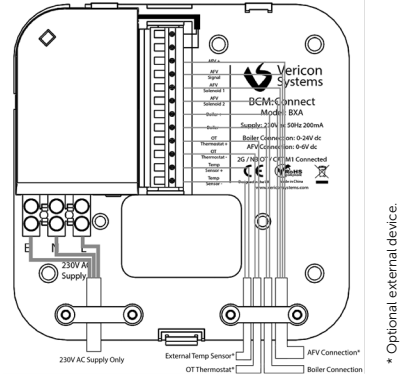

Note: Disconnect any OpenTherm thermostat from the boiler and reconnect to "OT Thermostat" connections on the BCM:Connect.

Connect a 230V AC supply from the boiler to the "230V AC Supply" connections on the left-hand side of the wall mount.

Connect the EBus, EMSbus or OpenTherm connection from the boiler to "Boiler +" and "Boiler -".

Connect any external devices as required.

LED Fault Finding Table

Red LED (Upper LED)

RED LED Status	Description
On	Device working on mains power.
Flashing	Device working on battery power. The device will power off after one minute.
Off	No power.

Green LED (Lower LED)

GREEN LED Status	Description
On	Device connected to the cloud and boiler.
Flashing (Once per second)	Device connected to boiler. Attempting to connect to cloud.
Flashing (Three times per second)	Device connected to cloud. Attempting to connect to boiler.
Off	Boiler and cloud connection not available.